

Features

- 500mW Power Dissipation on Ceramic PCB
- Very Tight Tolerance on V_Z
- Ideally Suited for Automated Assembly Processes
- **Lead, Halogen and Antimony Free, RoHS Compliant "Green" Device (Notes 2 and 3)**

Mechanical Data

- Case: SOD-123
- Case Material: Molded Plastic. UL Flammability Classification Rating 94V-0
- Moisture Sensitivity: Level 1 per J-STD-020D
- Terminal Connections: Cathode Band
- Terminals: Finish - Matte Tin annealed over Alloy 42 leadframe. Solderable per MIL-STD-202, Method 208
- Marking Information: See Page 6
- Ordering Information: See Page 6
- Weight: 0.01 grams (approximate)



Top View

Maximum Ratings @ $T_A = 25^\circ\text{C}$ unless otherwise specified

Characteristic	Symbol	Value	Unit
Forward Voltage @ $I_F = 10\text{mA}$	V_F	0.9	V

Thermal Characteristics

Characteristic	Symbol	Value	Unit
Power Dissipation (Note 1)	P_D	500	mW
Thermal Resistance, Junction to Ambient Air (Note 1)	$R_{\theta JA}$	305	$^\circ\text{C/W}$
Operating and Storage Temperature Range	T_J, T_{STG}	-65 to +150	$^\circ\text{C}$

- Notes:
1. Device mounted on ceramic PCB = 7.6mm x 9.4mm x 0.87mm with pad areas 25mm² at $T_A = 25^\circ\text{C}$ or mounted on FR-5 = 3.5x1.5 inches with recommended pad layout, which can be found on our website at <http://www.diodes.com/datasheets/ap02001.pdf>, at $T_L = 75^\circ\text{C}$.
 2. No purposefully added lead. Halogen and Antimony Free.
 3. Product manufactured with Data Code V9 (week 33, 2008) and newer are built with Green Molding Compound. Product manufactured prior to Date Code V9 are built with Non-Green Molding Compound and may contain Halogens or Sb_2O_3 Fire Retardants.

Electrical Characteristics @ $T_A = 25^\circ\text{C}$ unless otherwise specified

Type Number	Type Code	Zener Voltage Range (Note 4)				Maximum Reverse Leakage Current (Note 5)		
		$V_Z @ I_{ZT}$			I_{ZT}	$I_R @ V_R$		
		Nom (V)	Min (V)	Max (V)		μA	V	
DDZ9678	D1	1.8	1.71	1.89	50	7.5	1	
DDZ9681	H9	2.4	2.28	2.52	50	2	1	
DDZ9682	HA	2.7	2.565	2.835	50	1	1	
DDZ9683	HB	3.0	2.85	3.15	50	0.8	1	
DDZ9684	HC	3.3	3.13	3.47	50	7.5	1.5	
DDZ9685	HD	3.6	3.42	3.78	50	7.5	2	
DDZ9686	HE	3.9	3.70	4.10	50	5	2	
DDZ9687	HF	4.3	4.09	4.52	50	4	2	
DDZ9688	HG	4.7	4.47	4.94	50	5	3	
DDZ9689	HH	5.1	4.85	5.36	50	5	3	
DDZ9690	HJ	5.6	5.32	5.88	50	2	4	
DDZ9691	HK	6.2	5.89	6.51	50	1	5	
DDZ9692	HL	6.8	6.46	7.14	50	0.1	5.1	
DDZ9693	HM	7.5	7.13	7.88	50	0.1	5.7	
DDZ9694	HN	8.2	7.79	8.61	50	0.1	6.2	
DDZ9696	HP	9.1	8.65	9.56	50	0.1	6.9	
DDZ9697	HQ	10	9.50	10.50	50	0.1	7.6	
DDZ9698	HR	11	10.45	11.55	50	0.05	8.4	
DDZ9699	HS	12	11.40	12.60	50	0.05	9.1	
DDZ9700	HT	13	12.35	13.65	50	0.05	9.8	
DDZ9701	HU	14	13.30	14.70	50	0.05	10.6	
DDZ9702	HV	15	14.25	15.75	50	0.05	11.4	
DDZ9703	HW	16	15.20	16.80	50	0.05	12.1	
DDZ9704	H8	17	16.15	17.85	50	0.05	12.9	
DDZ9705	HY	18	17.10	18.90	50	0.05	13.6	
DDZ9707	MD	20	19.00	21.00	50	0.05	15.2	
DDZ9708	ME	22	20.90	23.10	50	0.05	16.7	
DDZ9709	MF	24	22.80	25.20	50	0.05	18.2	
DDZ9711	MH	27	25.65	28.35	50	0.05	20.4	
DDZ9712	MJ	28	26.60	29.40	50	0.05	21.2	
DDZ9713	MK	30	28.50	31.50	50	0.05	22.8	
DDZ9714	ML	33	31.35	34.65	50	0.05	25.0	
DDZ9715	MM	36	34.20	37.80	50	0.05	27.3	
DDZ9716	MN	39	37.05	40.95	50	0.05	29.6	
DDZ9717	MO	43	40.85	45.15	50	0.05	32.6	

Notes: 4. Nominal Zener voltage is measured with the device junction in thermal equilibrium at $T_T = 30^\circ\text{C} \pm 1^\circ\text{C}$.
 5. Short duration pulse test used to minimize self-heating effect.

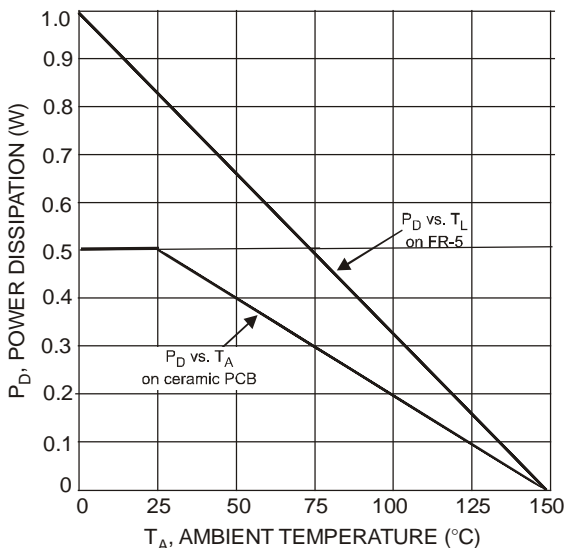

Fig. 1 Power Derating Curve

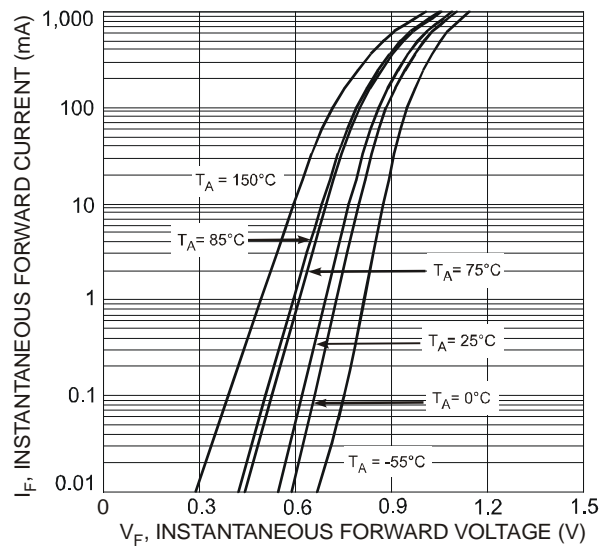

Fig. 2 Typical Forward Characteristics

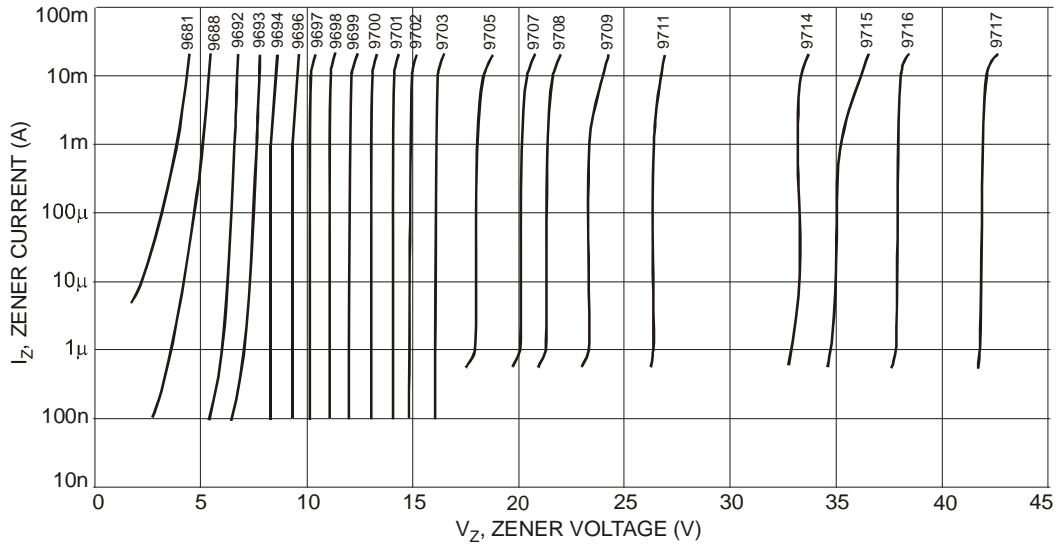

Fig. 3 Typical Zener Breakdown Characteristics

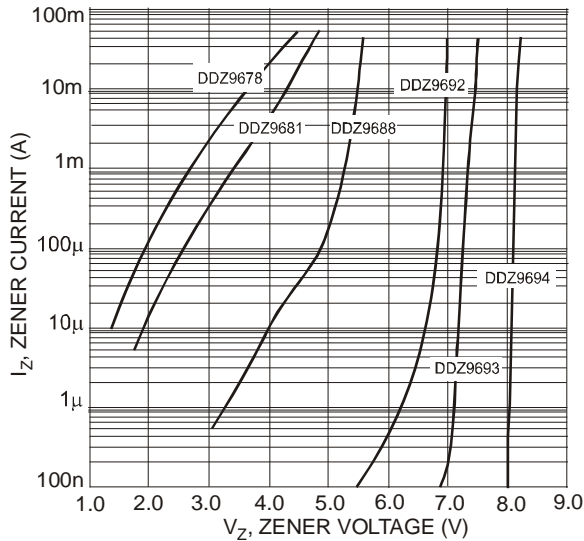

Fig. 4 Typical Zener Breakdown Characteristics, DDZ9678 - DDZ9694

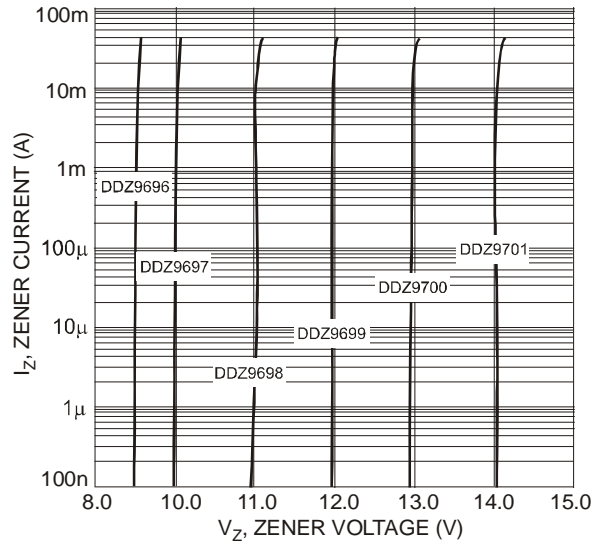

Fig. 5 Typical Zener Breakdown Characteristics, DDZ9696 - DDZ9701

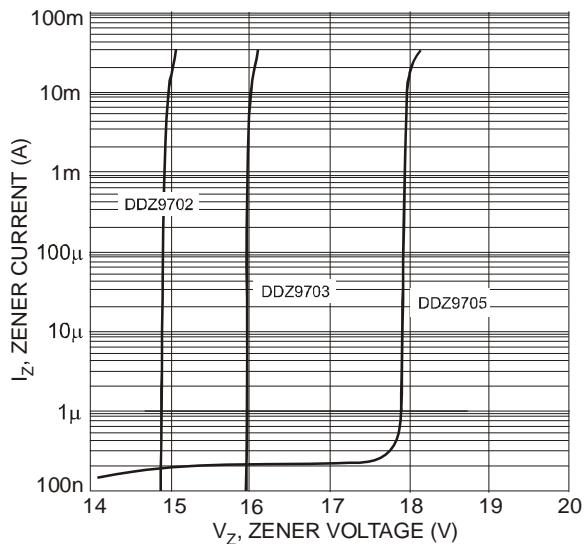

Fig. 6 Typical Zener Breakdown Characteristics, DDZ9702 - DDZ9705

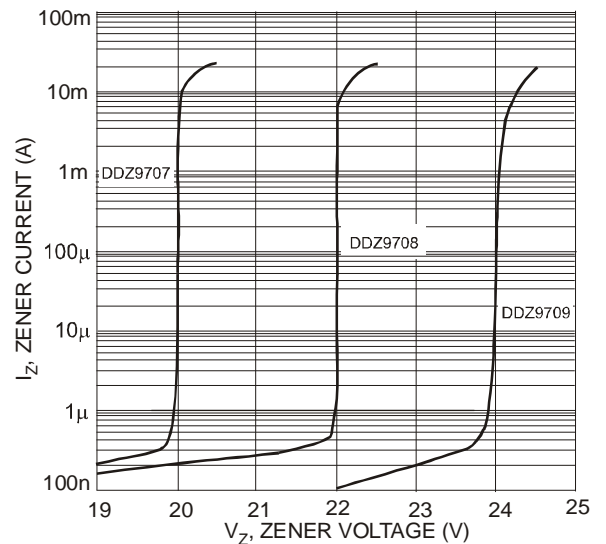

Fig. 7 Typical Zener Breakdown Characteristics, DDZ9707 - DDZ9709

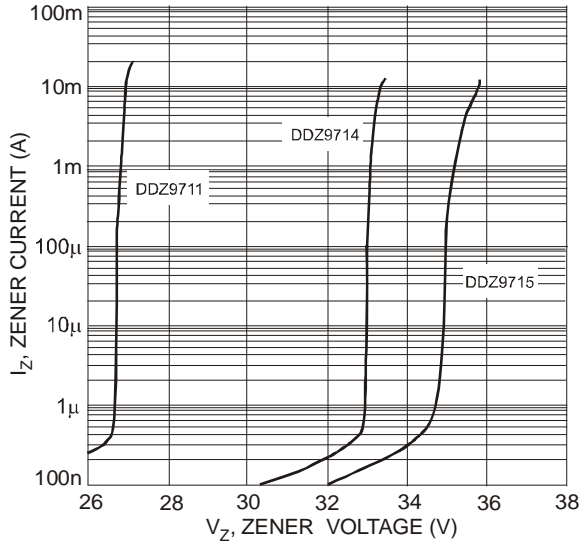

Fig. 8 Typical Zener Breakdown Characteristics, DDZ9711 - DDZ9715

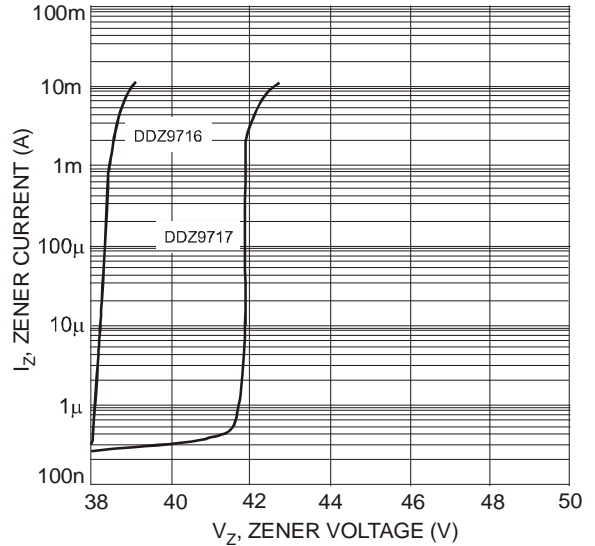

Fig. 9 Typical Zener Breakdown Characteristics, DDZ9716 - DDZ9717

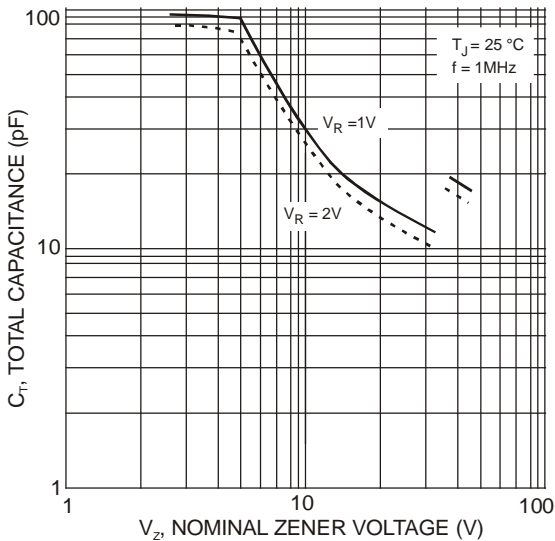

Fig. 10 Total Capacitance vs. Nominal Zener Voltage

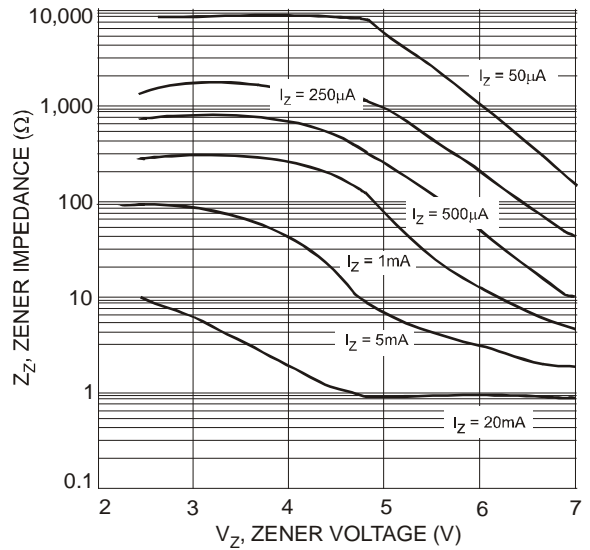

Fig. 11 Typical Zener Impedance Characteristics, DDZ9681 - DDZ9692

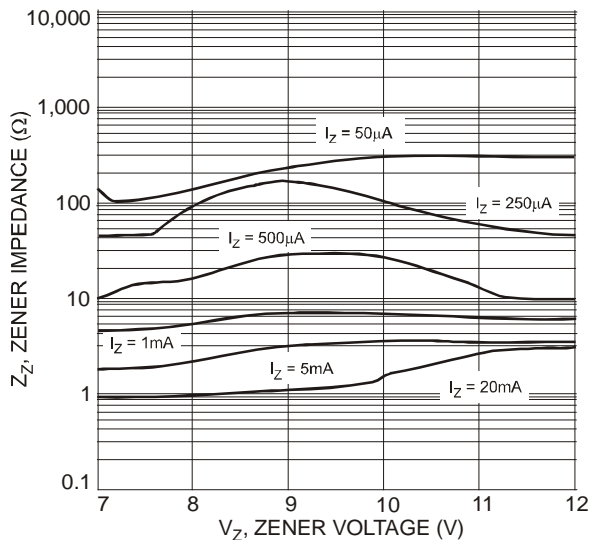

Fig. 12 Typical Zener Impedance Characteristics, DDZ9693 - DDZ9699

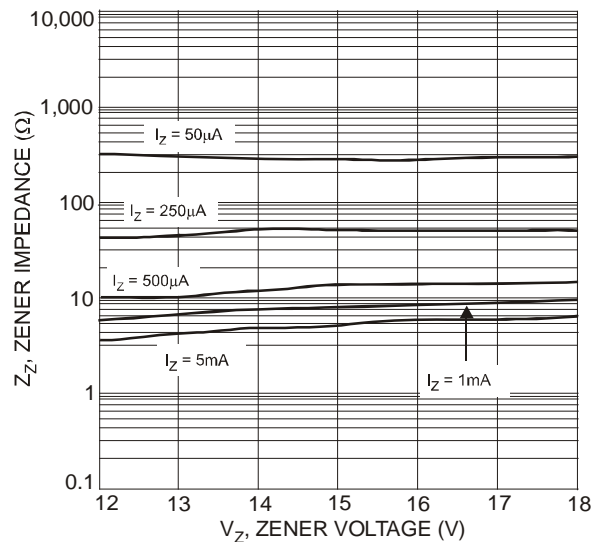

Fig. 13 Typical Zener Impedance Characteristics, DDZ9699 - DDZ9705

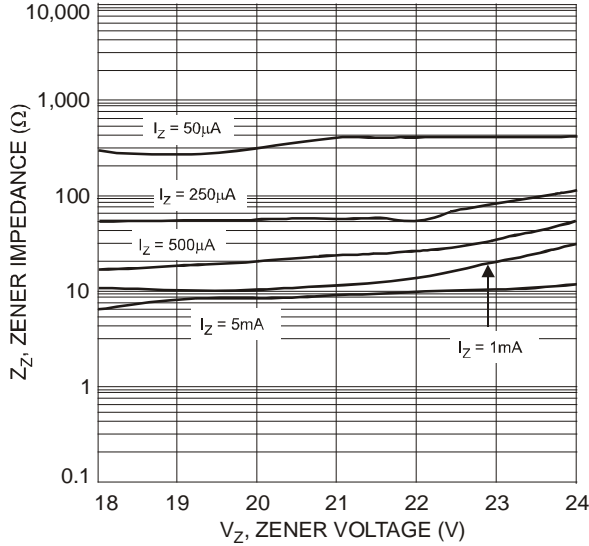

Fig. 14 Typical Zener Impedance Characteristics, DDZ9705 - DDZ9709

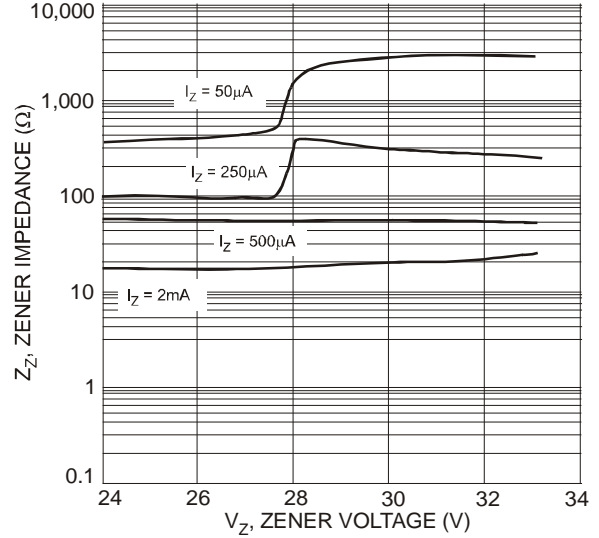

Fig. 15 Typical Zener Impedance Characteristics, DDZ9709 - DDZ9714

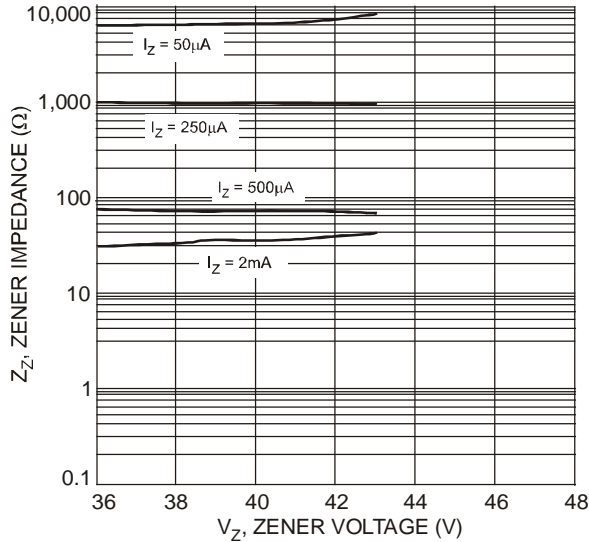

Fig. 16 Typical Zener Impedance Characteristics, DDZ9715 - DDZ9717

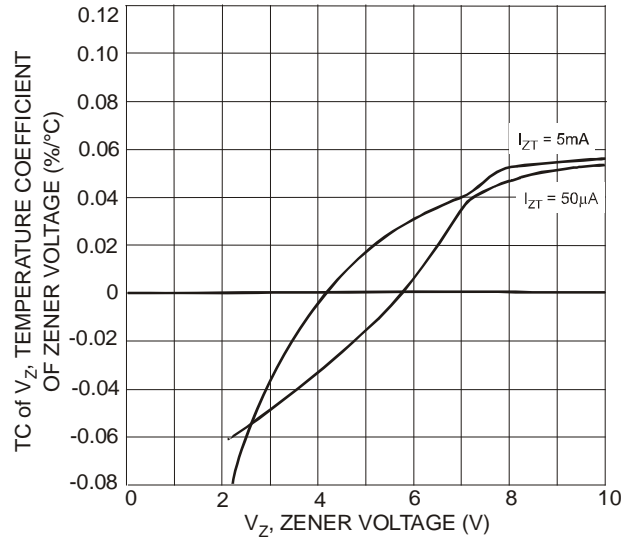

Fig. 17 Typical Temperature Coefficient of Zener Voltage vs. Zener Voltage, DDZ9681 - DDZ9697

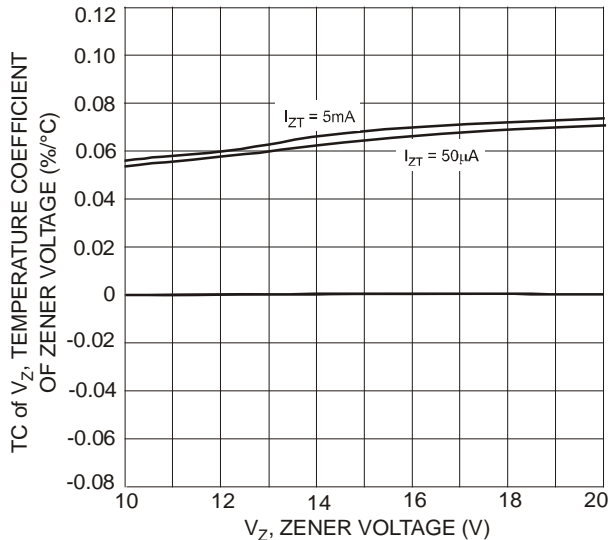

Fig. 18 Typical Temperature Coefficient of Zener Voltage vs. Zener Voltage, DDZ9697 - DDZ9707

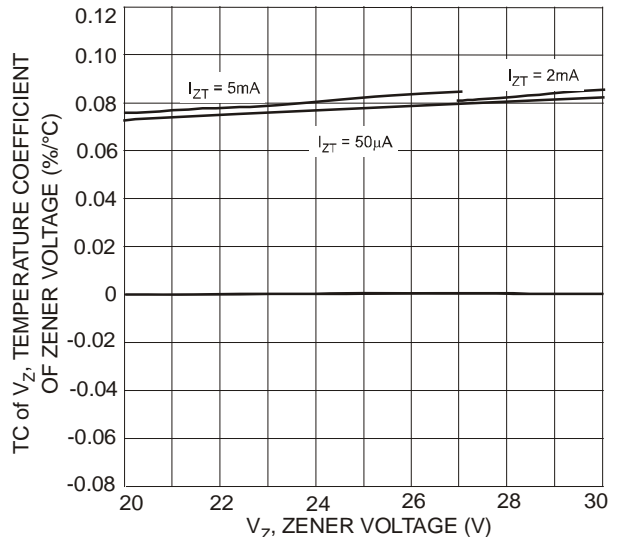

Fig. 19 Typical Temperature Coefficient of Zener Voltage vs. Zener Voltage, DDZ9707 - DDZ9713

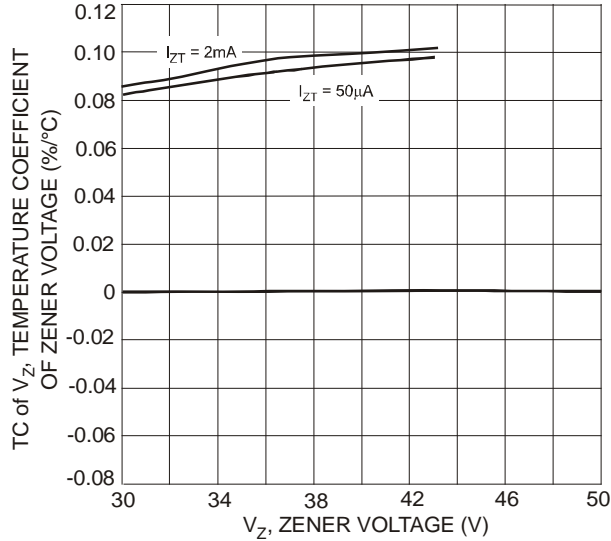

Fig. 20 Typical Temperature Coefficient of Zener Voltage vs. Zener Voltage, DDZ9713 - DDZ9717

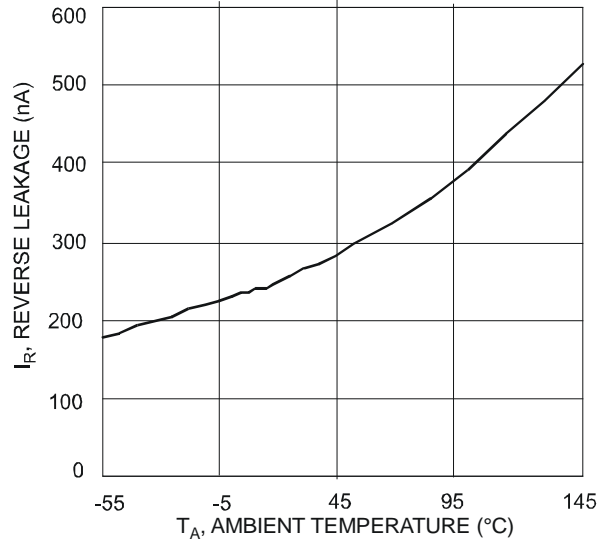

Fig. 21 Typical Leakage vs. Ambient Temperature, DDZ9681

Ordering Information (Note 6)

Part Number	Case	Packaging
(Type Number)-7*	SOD-123	3000/Tape & Reel

*Example: The part number for the 6.2 Volt device would be DDZ9691-7.

Notes: 6. For packaging details, go to our website at <http://www.diodes.com/datasheets/ap02007.pdf>.

Marking Information



xx = Product Type Marking Code,
(See Electrical Characteristics Table)
YM = Date Code Marking
Y = Year (ex: T = 2006)
M = Month (ex: 9 = September)

Date Code Key

Year	2006	2007	2008	2009	2010	2011	2012	2013	2014	2015
Code	T	U	V	W	X	Y	Z	A	B	C

Month	Jan	Feb	Mar	Apr	May	Jun	Jul	Aug	Sep	Oct	Nov	Dec
Code	1	2	3	4	5	6	7	8	9	O	N	D

Package Outline Dimensions

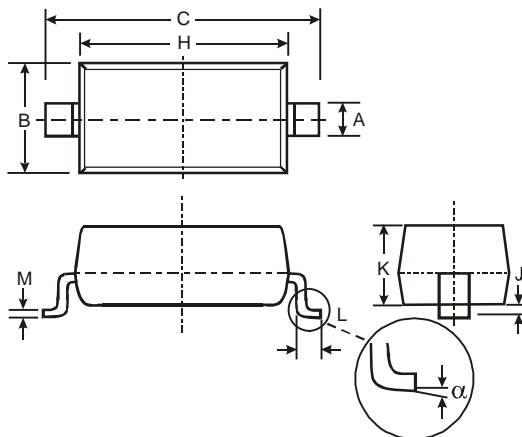

SOD-123		
Dim	Min	Max
A	0.55 Typ	
B	1.40	1.70
C	3.55	3.85
H	2.55	2.85
J	0.00	0.10
K	1.00	1.35
L	0.25	0.40
M	0.10	0.15
α	0	8°
All Dimensions in mm		

Suggested Pad Layout

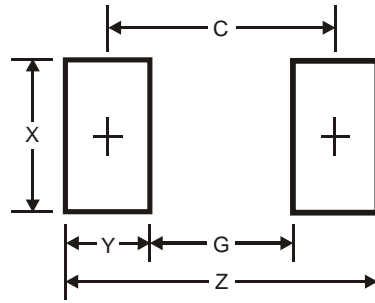

Dimensions	Value (in mm)
Z	4.9
G	2.5
X	0.7
Y	1.2
C	3.7

IMPORTANT NOTICE

Diodes Incorporated and its subsidiaries reserve the right to make modifications, enhancements, improvements, corrections or other changes without further notice to any product herein. Diodes Incorporated does not assume any liability arising out of the application or use of any product described herein; neither does it convey any license under its patent rights, nor the rights of others. The user of products in such applications shall assume all risks of such use and will agree to hold Diodes Incorporated and all the companies whose products are represented on our website, harmless against all damages.

LIFE SUPPORT

Diodes Incorporated products are not authorized for use as critical components in life support devices or systems without the expressed written approval of the President of Diodes Incorporated.